

# Fiberglass Molded Grating & Products

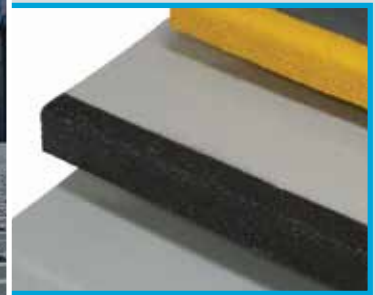

*Building the World to Last®*

HIGH PERFORMANCE COMPOSITE SOLUTIONS

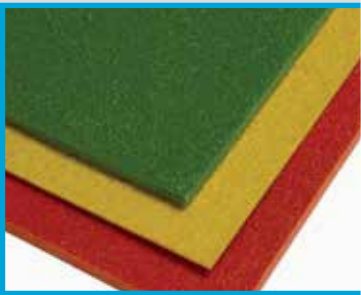

# Fiberglass Molded Products

## Introduction

Combining unmatched corrosion resistance with strength, long life and safety, Fibergate Composite Structures Inc. sets the standard for fiberglass reinforced plastic (FRP) molded products. With more than ten custom resins, Fibergate products are proven to deliver years of reliable service, even in the most demanding corrosive conditions — conditions which cause conventional metallic and wood products to deteriorate rapidly.



Fibergate products are lightweight and easy to fabricate. Savings on labor and equipment often make the total installed cost of Fibergate products comparable to that of steel. Combining these installation savings with low maintenance, long life and worker safety, Fibergate products offer a life cycle cost that is significantly lower than that of metallic products.

Fibergate's molded grating line includes Fibergate® molded grating for most applications, Fibergate® molded high load capacity grating for H-20 and forklift traffic, Micro-Mesh® for access flooring and for docks and marinas, Airmesh® screening and Multigrid® grating. For applications requiring a solid walkway, Fibergate carries Fiberplate® structural floor panels and Fibergate® covered grating. Stair solutions include Fibertred® stair tread panels for industrial and commercial use, covered stair treads for architectural applications and stair tread covers for existing stairways. Ergonomic work platform solutions include Safe-T-Stand® platforms, which are available in varying heights, and raised ergonomic workmats. Fibergate now offers FGI-AM molded grating with Microban. Microban is infused in the resin to prohibit the growth of odor and stain-causing bacteria for the food and beverage industry.



Fibergate's complete line of molded products and turnkey services offers a variety of solutions for most applications.

## Fibergate Markets

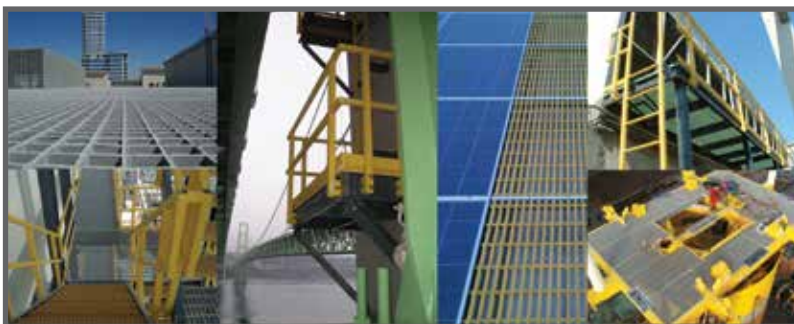

- Architectural
- Bridge & Highway
- Chemical
- Commercial
- Food & Beverage
- Manufacturing
- Metals & Mining
- Microelectronics
- Oil & Gas
- Pharmaceutical
- Power
- Pulp & Paper
- Recreation
- Telecommunications
- Transportation
- Water & Wastewater

# Fibergrate® Benefits

## Why use FRP?



**Corrosion Resistant:** Fibergrate® molded fiberglass products are known for their ability to provide corrosion resistance in the harshest environments and chemical exposures.



**Slip Resistant:** The meniscus and integrally applied grit surfaces of Fibergrate molded products have unmatched slip resistance for improved worker safety.



**Low Maintenance:** The corrosion resistant properties of FRP grating and other products reduce or eliminate the need for sandblasting, scraping and painting. Products are also easily cleaned with a high pressure washer.



**Fire Retardant:** Most Fibergrate products are engineered to have a flame spread rating of 25 or less, as tested in accordance with ASTM E-84, and meet the self-extinguishing requirements of ASTM D-635.



**High Strength to Weight Ratio:** Less than one-half the weight of steel grating, allowing easy removal for access below floor level and installation with no heavy equipment and less manpower.



**Electrically & Thermally Non Conductive:** Fiberglass is electrically non conductive for safety and has low thermal conductivity which results in a more comfortable product when physical contact occurs.



**Impact Resistant:** Fibergrate molded products show superior impact resistance when compared to steel gratings.



**Low Install Cost:** Due to ease of fabrication and light weight, FRP molded grating eliminates the need for heavy lifting equipment.



**Long Service Life:** Fiberglass products provide outstanding durability and corrosion resistance in demanding applications, therefore providing improved product life over traditional materials.



### NSF® Standard 61-Certified:

NSF Standard 61-Certified molded grating is available in all Fibergrate® molded grating mesh patterns and thicknesses, except Ecograte® and 4 x 12 Micro-Mesh® panels. These molded gratings complement the complete line of NSF Standard 61-Certified Dynaform® fiberglass structural shapes, Dynarail® FRP guardrail, handrail and ladder systems, and Safe-T-Span® pultruded gratings assembled from NSF Standard 61-Certified FRP components.



### Heavy Metal Safe:





The EPA, OSHA and other regulatory agencies created to protect our lives and our natural resources have increased legislation to control heavy metals such as lead, chrome, cadmium and other metals in all products where exposure is a health threat. Fibergrate Composite Structures Inc. supports this strengthened legislation and has, for more than 20 years, voluntarily tested for heavy metals in our products and minimized or eliminated heavy metals from our products.

## Table of Contents:

Molded Grating Selection Chart	P. 4
Grating Details	P. 4-6
Resins	P. 7
Surfaces/Options	P. 8
Molded Grating Load Charts	P. 9-11
High Load Capacity Grating	P. 12-13
Stair Solutions	P. 14-15
Floor Plate	P. 16
Accessories/Complementary Products	P. 17
Other Molded Products	P. 18
Chemical Resistance Guide	P. 19

# Molded Grating Selection & Details

## Fibergate® Molded Grating

Brand	Depth	Mesh	Standard Panel Sizes	Wt. Per Sq. Ft.	Open Area
Airmesh®	1/2"	1-1/2" x 1-1/2" square	4' x 8' ( <i>non-load carrying product</i> )	0.8 lb	87%
Multigrid®	1/2"	2" x 2" square	4' x 12', 4' x 15' ( <i>must be fully supported</i> )	1.0 lb	82%
Fibergate®	5/8"	1" x 4" rectangular	12' x 4'	2.0 lb	58%
Fibergate	3/4"	1" x 4" rectangular	10' x 3', 8' x 4'	2.5 lb	69%
Fibergate	3/4"	1-1/2" x 1-1/2" square	3' x 10', 4' x 8', 4' x 12'	2.0 lb	70%
Micro-Mesh® 	1"	Top 3/4" sq, Btm 1-1/2" sq	4' x 12'	2.9 lb	44.4%
Ecograte®62 	1"	3/4" x 4" rectangular	4' x 12'	3.0 lb	62%
Fibergate	1"	1" x 4" rectangular	10' x 3', 8' x 4'	2.5 lb	69%
Fibergate	1"	1-1/2" x 1-1/2" square	3' x 10', 4' x 8', 4' x 12'	2.5 lb	70%
Fibergate	1"	2" x 2" square	4' x 12'	1.7 lb	76%
Fibergate	1-1/4"	1-1/2" x 1-1/2" square	3' x 10', 4' x 8', 4' x 12', 5' x 10'	3.2 lb	70%
Fibergate	1-1/2"	1-1/2" x 1-1/2" square	3' x 10', 4' x 8', 4' x 12', 5' x 10'	3.8 lb	70%
High Load 	1-1/2"	1" x 2" rectangular	6' x 4', 4' x 8'	6.2 lb	48%
Micro-Mesh®	1-1/2"	Top 3/4" sq, Btm 1-1/2" sq	2' x 2', 4' x 12'	4.5 lb	44.4%
Fibergate	2"	2" x 2" square	4' x 12'	4.0 lb	72%
High Load 	2"	1" x 2" rectangular	6' x 4', 4' x 8'	8.4 lb	48%

See page 8 for surface selection.

## Grating Details

### Airmesh® 1/2" Deep x 1-1/2" Square Mesh

# of Bars/ Ft of Width	Load Bar Width	Open Area	Load Bar Centers	Approximate Weight
8	1/8"	87%	1-1/2"	0.8 psf

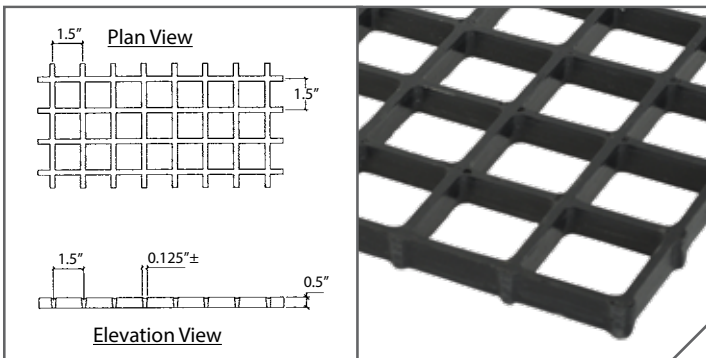

Designed for screening applications only

### Multigrid® 1/2" Deep x 2" Square Mesh

# of Bars/ Ft of Width	Load Bar Width	Open Area	Load Bar Centers	Approximate Weight
6	3/16"	82%	2"	0.96 psf

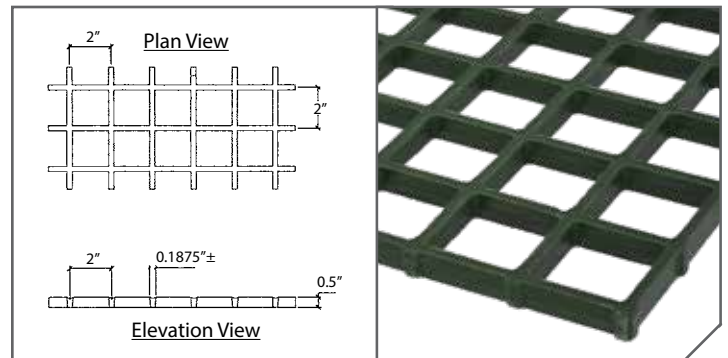

Must be fully supported in walking surface applications

# Molded Grating Details

## Micro-Mesh® 1" & 1-1/2" Deep x 3/4" Sq Top Mesh



Depth	Square Top Mesh	Panel Size	# of Bars/ Ft of Width	Load Bar Width	Open Area	Load Bar Centers	Approximate Weight
1"	3/4"	4' x 12'	8	1/4"	44.4%	1-1/2"	2.9 psf
1-1/2"	3/4"	4' x 12'	8	1/4"	44.4%	1-1/2"	4.5 psf

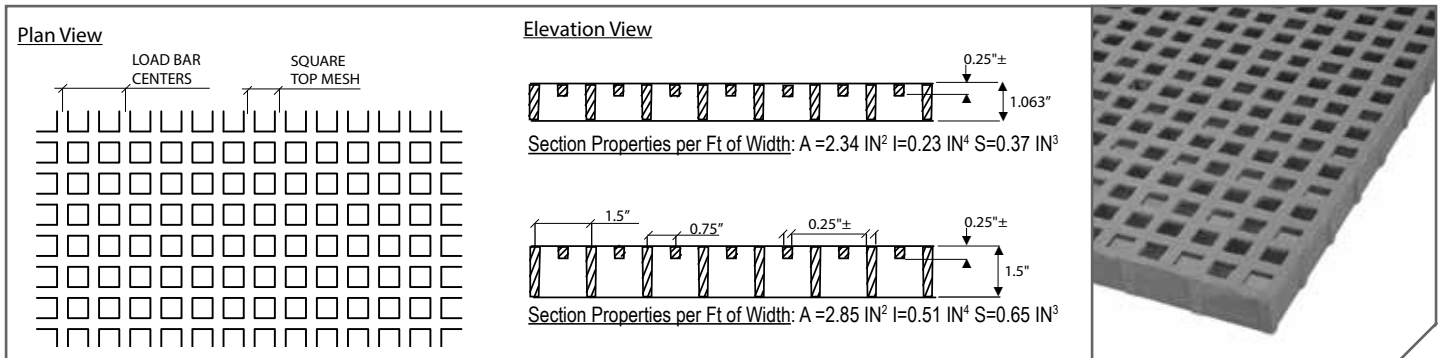

## 5/8" Deep x 1" x 4" Rectangular Mesh\*

# of Bars/ Ft of Width	Load Bar Width	Open Area	Load Bar Centers	Approximate Weight
12	5/16"	58%	1"	1.98 psf

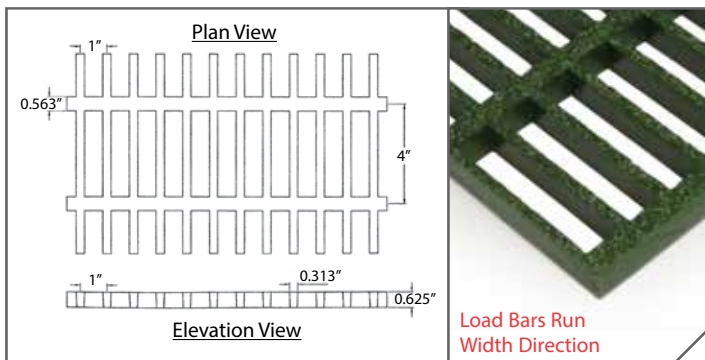

Section Properties per Ft of Width: A = 2.11 IN<sup>2</sup> I = 0.07 IN<sup>4</sup> S = 0.22 IN<sup>3</sup>  
\*Not available with meniscus top surface (only grit)



## 1" Deep x 3/4" x 4" Rectangular Mesh

# of Bars/ Ft of Width	Load Bar Width	Open Area	Load Bar Centers	Approximate Weight
16	1/4"	62%	3/4"	3.0 psf

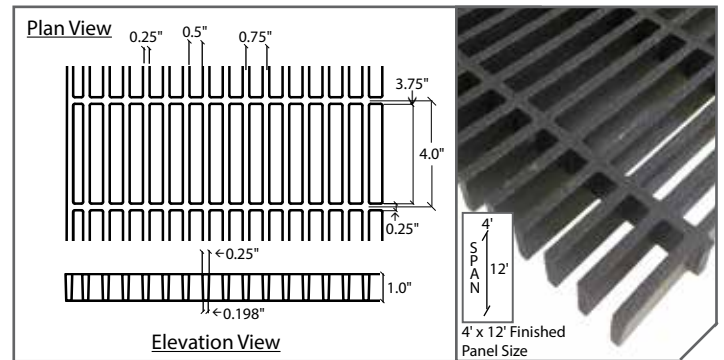

Section Properties per Ft of Width: A = 3.58 IN<sup>2</sup> I = 0.298 IN<sup>4</sup> S = 0.573 IN<sup>3</sup>

## 1" Deep x 1" x 4" Rectangular Mesh\*

Panel Sizes	# of Bars/ Ft of Width	Load Bar Width	Tie Bar Width	Open Area	Load Bar Centers	Approx. Weight
Design A 10' x 3' 8' x 4'	12	1/4"	3/8"	69%	1"	2.5 psf

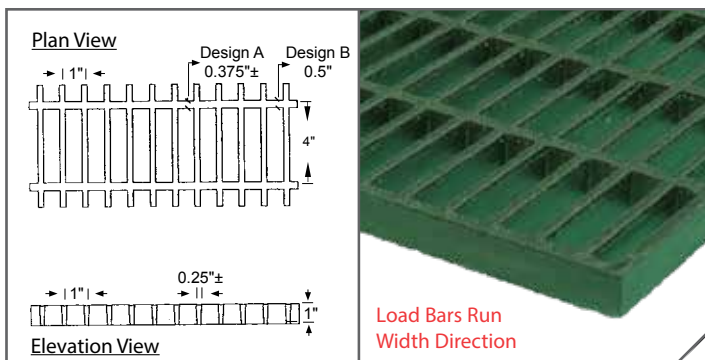

Section Properties per Ft of Width: A = 2.57 IN<sup>2</sup> I = 0.22 IN<sup>4</sup> S = 0.43 IN<sup>3</sup>

## 1" Deep x 1-1/2" Square Mesh

# of Bars/ Ft of Width	Load Bar Width	Open Area	Load Bar Centers	Approximate Weight
8	1/4"	70%	1-1/2"	2.5 psf

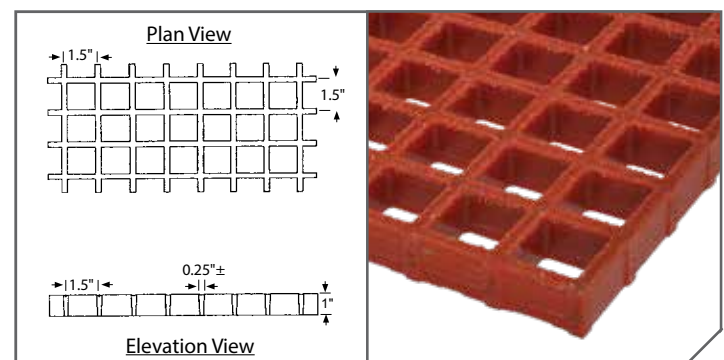

Section Properties per Ft of Width: A = 1.71 IN<sup>2</sup> I = 0.14 IN<sup>4</sup> S = 0.29 IN<sup>3</sup>

# Molded Grating Details

## 1" Deep x 2" Square Mesh

# of Bars/ Ft of Width	Load Bar Width	Open Area	Load Bar Centers	Approximate Weight
6	0.3"	76%	2"	1.7 psf

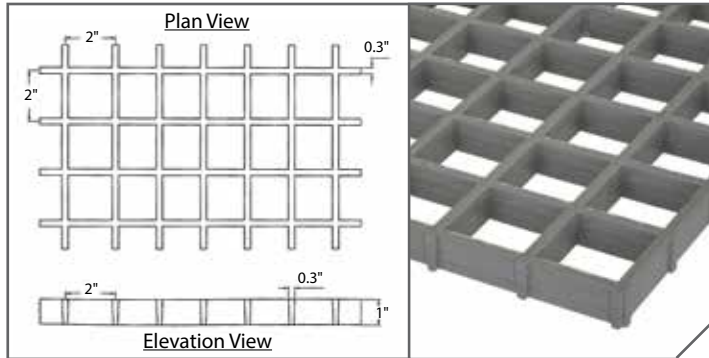

Section Properties per Ft of Width:  $A = 1.27 \text{ IN}^2$   $I = 0.11 \text{ IN}^4$   $S = 0.21 \text{ IN}^3$

## 1-1/4" Deep x 1-1/2" Square Mesh\*

# of Bars/ Ft of Width	Load Bar Width	Open Area	Load Bar Centers	Approximate Weight
8	1/4"	70%	1-1/2"	3.2 psf

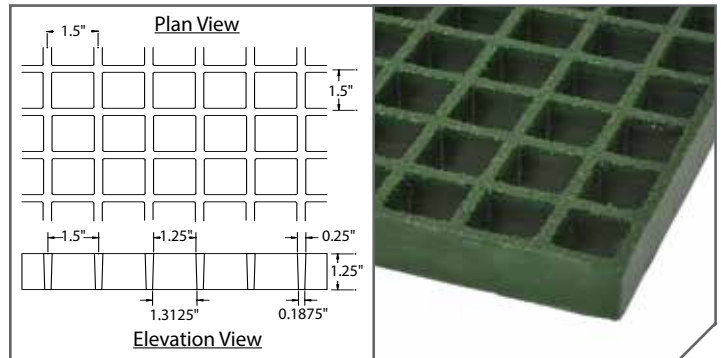

Section Properties per Ft of Width:  $A = 2.16 \text{ IN}^2$   $I = 0.32 \text{ IN}^4$   $S = 0.48 \text{ IN}^3$

\*Not available with meniscus top surface (only grit)

## 1-1/2" Deep x 1-1/2" Square Mesh

# of Bars/ Ft of Width	Load Bar Width	Open Area	Load Bar Centers	Approximate Weight
8	1/4"	70%	1-1/2"	3.8 psf

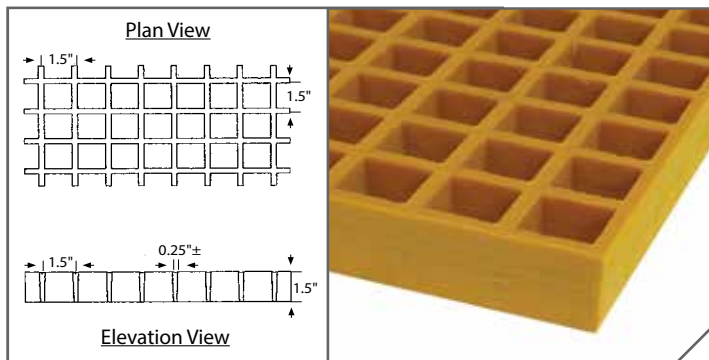

Section Properties per Ft of Width:  $A = 2.85 \text{ IN}^2$   $I = 0.51 \text{ IN}^4$   $S = 0.65 \text{ IN}^3$

## HLC 1-1/2" Deep x 1" x 2" Rectangular Mesh

# of Bars/ Ft of Width	Load Bar Width	Open Area	Load Bar Centers	Approximate Weight
12	0.43"	48%	1"	6.2 psf

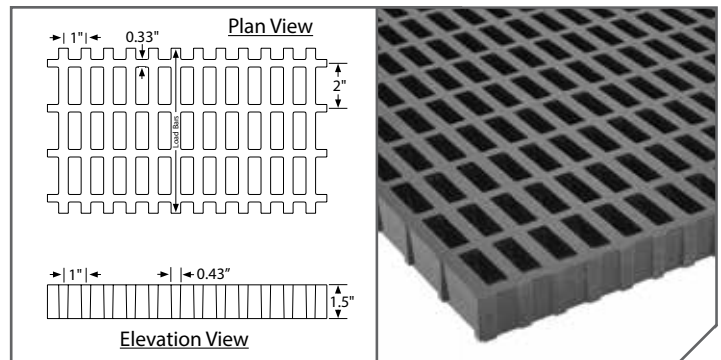

Section Properties per Ft of Width:  $A = 7.45 \text{ IN}^2$   $I = 1.39 \text{ IN}^4$   $S = 1.80 \text{ IN}^3$

## 2" Deep x 2" Square Mesh

# of Bars/ Ft of Width	Load Bar Width	Open Area	Load Bar Centers	Approximate Weight
6	0.3"	72%	2"	4.0 psf

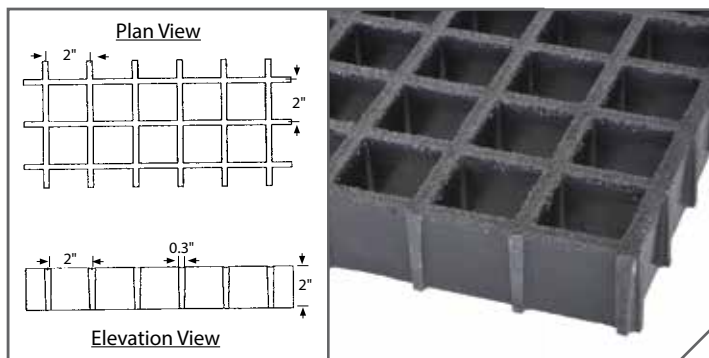

Section Properties per Ft of Width:  $A = 2.88 \text{ IN}^2$   $I = 0.96 \text{ IN}^4$   $S = 0.94 \text{ IN}^3$

## HLC 2" Deep x 1" x 2" Rectangular Mesh

# of Bars/ Ft of Width	Load Bar Width	Open Area	Load Bar Centers	Approximate Weight
12	0.48"	48%	1"	8.4 psf

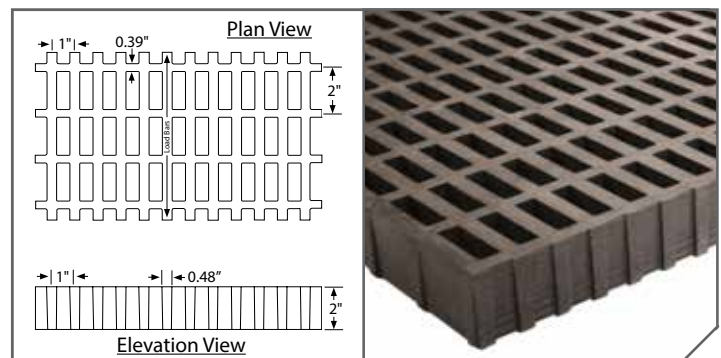

Section Properties per Ft of Width:  $A = 10.26 \text{ IN}^2$   $I = 3.4 \text{ IN}^4$   $S = 3.27 \text{ IN}^3$

# Molded Grating Resins

Corrosion in the workplace negatively impacts your bottom line. Each year, industrial plant executives eliminate expensive corrosion-related maintenance problems by switching to Fibergrate® molded grating. Various applications present different requirements so Fibergrate offers numerous standard resin systems to address multiple needs.

## Fibergrate® Standard Resins

**Vi-Corr®:** A superior vinyl ester resin developed for reliable performance in the toughest environments. It offers outstanding resistance to a wide range of highly corrosive situations, from caustic to acidic. In fact, no other resin system can match the performance of Vi-Corr in highly acidic environments. [Vi-Corr has replaced VE-25](#). Color: orange or dark gray. Flame spread: ASTM E84 rating of 25 or less. Certifications: DNV GL Type Approval No. TAF000003C; ABS Type Approval No. 01-HS34733-X; meets the USCG requirements for general fire rating\*.

**FGI-AM®:** This NEWLY improved food-grade isophthalic polyester resin system is infused with Microban® antimicrobial product protection which inhibits the growth of odor and stain-causing bacteria for the lifespan of the product. Fibergrate's FGI-AM resin offers the necessary corrosion resistance to meet the requirements of the food and beverage industry. This product is intended only for non-public health uses. Color: light gray or green. Flame Spread: ASTM E84 rating of 25 or less. Certifications: USDA Approvable.



**Corvex®:** This newly improved isophthalic polyester resin system outperforms a number of competitive fiberglass and metal products and meets the requirements for corrosion resistance found in industrial, chemical processing and water/wastewater applications. [This upgraded formulation has replaced IFR, CP-84 and FS-25 resins](#). Color: yellow, dark gray, or dark green. Flame Spread: ASTM E84 rating of 25 or less. Certifications: meets the USCG requirements for general fire rating\*.

**XFR:** This eXtra Fire Retardant vinyl ester resin is recommended for use where the fire potential is high. Color: dark gray. Flame Spread: ASTM E84 rating of 10 or less, a level exceeded by no other resin system. Certifications: meets the USCG requirements for general fire rating\*.

**ELS:** This Extremely Low Smoke resin is an acrylic-modified polyester system that is ideal for tunnel, offshore, mass transit and other confined space applications. ELS exhibits low ignitability, low smoke generation and extremely low smoke toxicity. Color: dark gray. Flame Spread: ASTM E84: flame spread index of 25 or less, a smoke developed index of 100 or less and Fuel Contribution of 0. Certifications: DNV GL Type Approval No. TAF000003C; meets the USCG requirements for general fire rating\*.

**Super Vi-Corr®:** This family of resin systems consists of more than 30 custom formulas engineered to provide corrosion control solutions in applications that are too severe for conventional FRP and other building materials. Each Super Vi-Corr resin was engineered for the best possible performance in specific chemical and/or elevated temperature environments. These systems exist for aggressive chemical service in reagents like solvents, acidic oxidizers, chlorine dioxide, sodium hypochlorite and liquid desiccants. Certain formulas are also suited for elevated temperature applications up to 400° F. Super Vi-Corr gratings are typically used for packing hold-downs and support in environmental and process scrubber applications. Color: natural - tan to beige. Flame Spread: non fire retardant, unless specified.

*\*For specific requirements and questions, please contact technical services.*

## Specialty

Fibergrate also offers specialty resins custom designed to meet your specific needs. These special formulations are developed to address unique and demanding services and applications, as well as niche market needs (Super Vi-Corr family of resins).

We can engineer resin systems to address temperature, flame, smoke and toxicity requirements. Our HSUV resin system was developed to address the intense UV effects found in offshore applications. Fibergrate's custom formulations with low smoke/toxicity properties were engineered with the United States Navy for below-deck marine service.

**Architectural Formulations:** Fibergrate's standard formulations are designed for industrial and corrosive applications. Special formulations and colors are required to meet the unique demands of architectural, fountain and pool projects. Please contact Fibergrate for additional information.

# Molded Grating Surfaces and Options

## Slip Resistant Surfaces

Slips and falls are the second leading cause of industrial accidents. According to the National Safety Council, each injury related lost work day can cost \$50,000 to \$100,000. That is why Fibergrate developed two slip resistant surfaces for flooring and stair solutions. These surfaces include meniscus and integrally applied grit tops in the Fibergrate resins.

## Available Surfaces for Molded Grating



**Meniscus Top:** The concave surface of Fibergrate® meniscus top grating provides superior slip resistant footing in most environments including wet or oily conditions. It is the standard surface for most Fibergrate molded gratings.

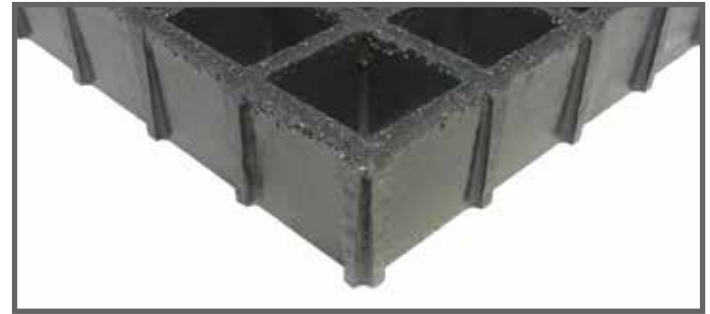

**Integrally Applied Grit Top:** The optional grip top of Fibergrate® grating has a quartz grit which is integrally applied, cured and sealed onto the surface providing excellent slip resistant footing.

**Please note** - The following molded grating panels are **only available with the grit top** surface (meniscus top not an option):  
5/8" deep, 1" x 4" rect. mesh, 12' x 4' panel; 1-1/4" deep, 1-1/2" square mesh

## Specialty Molded Products

**FRP Conductive Surface:** Fibergrate® Conductive Surface Grating properties are based on the requirements found in [NFPA 77, Recommended Practice on Static Electricity, 2000 Edition](#). The specification values below are minimum values based upon the guidance of NFPA 77, and apply only when the product is clean and grounded. Fibergrate recommends a minimum of 4 grounding attachments at the corners of a section of grating.

- Average Surface Resistivity –  $2.5 \times 10^3$  ohms to  $1 \times 10^6$  ohms per lineal foot
- Average Resistance to Ground –  $<10^8$  ohms

**Fibergrate HF Molded Grating:** Fibergrate has combined a premium-grade vinyl ester resin and exotic reinforcements to manufacture the only molded grating system suitable for service in harsh hydrofluoric acid applications. HF Molded Grating, a non fire retardant system, can see service in applications that would cause premature failure in most traditional molded grating systems.

**NSF® Standard 61-Certified Molded Gratings:** Fibergrate now manufactures NSF Standard 61-Certified grating. NSF formulated molded grating is available by special order in dark gray and light gray colors. Molded grating is also available in all of the molded grating mesh patterns and grating thicknesses, except Ecograte® and 4 x 12 Micro-Mesh® panels. Our NSF Standard 61-Certified structural shapes, handrails, ladders and pultruded FRP components can be combined to create valuable, long-lasting stairways, walkways and platforms.

## Custom Molded Products

Fibergrate has the capability to offer molded grating configurations designed/manufactured to meet your unique application requirements. Fibergrate's custom services include special molded grating configurations as well as custom hand-lay-up (HLU) products for industrial and architectural applications designed to meet your specific performance requirements.



# Load Tables - Fibergrate® Molded Gratings

MOLDED GRATING UNIFORM LOAD TABLES - DEFLECTION IN INCHES												MAX RECOM. LOAD (psf)	ULTIMATE CAPACITY (psf)
CLEAR SPAN (in)	STYLE		LOAD (psf)										
	DEPTH (in)	MESH (in x in)	50	65	100	150	200	300	500	1000	2000		
12	5/8	1 x 4	0.01	0.02	0.03	0.04	0.05	0.08	--	--	--	1540	7720
	3/4	1 x 4	<.01	<.01	0.01	0.01	0.02	0.02	0.04	0.08	0.15	1350	8130
	3/4	1-1/2 x 1-1/2	<.01	<.01	0.01	0.02	0.02	0.04	0.06	0.12	--	1000	6000
	1	3/4 x 3/4	<.01	<.01	<.01	<.01	0.01	0.02	0.03	0.06	0.12	1770	8880
	1	3/4 x 4	<.01	<.01	<.01	<.01	<.01	0.01	0.02	0.04	0.08	2800	14040
	1	1 x 4	<.01	<.01	<.01	<.01	<.01	0.01	0.02	0.05	0.09	2140	10700
	1	1-1/2 x 1-1/2	<.01	<.01	<.01	<.01	<.01	0.02	0.04	0.08	0.16	1420	7120
	1	2 x 2	<.01	0.01	0.02	0.03	0.04	0.06	--	--	--	1020	5140
	1-1/4	1-1/2 x 1-1/2	<.01	<.01	<.01	<.01	<.01	0.01	0.02	0.04	--	1110	6660
	1-1/2*	1-1/2 x 1-1/2	<.01	<.01	<.01	<.01	<.01	0.01	0.02	0.04	0.07	3200	16000
2	2 x 2	<.01	<.01	<.01	<.01	<.01	<.01	0.01	0.02	0.04	3840	19240	
18	5/8	1 x 4	0.05	0.07	0.11	0.16	0.22	--	--	--	--	680	3410
	3/4	1 x 4	0.02	0.02	0.04	0.06	0.08	0.11	0.19	--	--	600	3610
	3/4	1-1/2 x 1-1/2	0.03	0.04	0.06	0.09	0.12	0.18	0.30	--	--	440	2660
	1	3/4 x 3/4	0.01	0.02	0.03	0.04	0.06	0.08	0.14	0.28	--	780	3940
	1	3/4 x 4	0.01	0.01	0.02	0.03	0.04	0.06	0.10	0.20	0.40	1240	6200
	1	1 x 4	0.01	0.01	0.02	0.03	0.04	0.07	0.11	0.22	0.44	950	4750
	1	1-1/2 x 1-1/2	0.02	0.02	0.04	0.06	0.08	0.11	0.2	0.38	--	630	3170
	1	2 x 2	0.04	0.05	0.08	0.11	--	--	--	--	--	450	2290
	1-1/4	1-1/2 x 1-1/2	0.01	0.01	0.02	0.03	0.04	0.06	0.09	0.19	--	740	4440
	1-1/2*	1-1/2 x 1-1/2	<.01	<.01	0.01	0.02	0.03	0.04	0.07	0.14	0.28	1420	7100
2	2 x 2	<.01	<.01	0.01	0.01	0.02	0.03	0.04	0.09	0.17	1850	9280	
24	5/8	1 x 4	0.15	0.19	0.3	0.45	--	--	--	--	--	380	1920
	3/4	1 x 4	0.06	0.08	0.12	0.18	0.24	0.36	--	--	--	330	2030
	3/4	1-1/2 x 1-1/2	0.09	0.12	0.18	0.28	0.37	--	--	--	--	250	1500
	1	3/4 x 3/4	0.04	0.05	0.08	0.12	0.16	0.24	0.41	--	--	440	2220
	1	3/4 x 4	0.03	0.04	0.06	0.09	0.12	0.18	0.30	--	--	700	3500
	1	1 x 4	0.04	0.05	0.07	0.11	0.15	0.22	0.37	--	--	530	2670
	1	1-1/2 x 1-1/2	0.06	0.08	0.12	0.19	0.25	0.37	--	--	--	350	1780
	1	2 x 2	0.11	0.14	0.21	0.32	--	--	--	--	--	250	1280
	1-1/4	1-1/2 x 1-1/2	0.03	0.04	0.06	0.09	0.11	0.17	0.29	--	--	440	2660
	1-1/2*	1-1/2 x 1-1/2	0.02	0.03	0.04	0.06	0.08	0.12	0.21	0.42	--	800	4000
2	2 x 2	0.01	0.01	0.02	0.03	0.04	0.06	0.10	0.20	--	1040	5220	
30	5/8	1 x 4	0.32	0.41	--	--	--	--	--	--	--	240	1230
	3/4	1 x 4	0.13	0.17	0.26	0.40	--	--	--	--	--	210	1300
	3/4	1-1/2 x 1-1/2	0.17	0.23	0.35	--	--	--	--	--	--	160	960
	1	3/4 x 3/4	0.10	0.13	0.20	0.29	0.39	--	--	--	--	280	1400
	1	3/4 x 4	0.07	0.10	0.15	0.22	0.30	0.44	--	--	--	440	2200
	1	1 x 4	0.08	0.11	0.17	0.26	0.34	--	--	--	--	340	1710
	1	1-1/2 x 1-1/2	0.14	0.18	0.27	0.41	--	--	--	--	--	220	1140
	1	2 x 2	0.24	0.31	0.48	--	--	--	--	--	--	160	820
	1-1/4	1-1/2 x 1-1/2	0.08	0.10	0.15	0.23	0.30	0.46	--	--	--	280	1700
	1-1/2*	1-1/2 x 1-1/2	0.05	0.06	0.09	0.14	0.18	0.27	0.46	--	--	510	2560
2	2 x 2	0.02	0.03	0.05	0.07	0.09	0.14	0.26	0.45	--	660	3340	
36	3/4	1 x 4	0.25	0.33	--	--	--	--	--	--	--	150	900
	3/4	1-1/2 x 1-1/2	0.39	--	--	--	--	--	--	--	--	110	660
	1	3/4 x 3/4	0.20	0.26	0.40	--	--	--	--	--	--	190	990
	1	3/4 x 4	0.15	0.20	0.31	0.46	--	--	--	--	--	310	1500
	1	1 x 4	0.16	0.21	0.32	0.49	--	--	--	--	--	230	1180
	1	1-1/2 x 1-1/2	0.31	0.40	--	--	--	--	--	--	--	150	790
	1	2 x 2	0.46	--	--	--	--	--	--	--	--	110	570
	1-1/4	1-1/2 x 1-1/2	0.14	0.18	0.28	0.42	--	--	--	--	--	190	1180
	1-1/2*	1-1/2 x 1-1/2	0.1	0.13	0.20	0.30	0.40	--	--	--	--	350	1770
	2	2 x 2	0.04	0.06	0.09	0.13	0.18	0.26	0.44	--	--	460	2320
42	1	3/4 x 3/4	0.37	0.48	--	--	--	--	--	--	--	140	720
	1	3/4 x 4	0.28	0.37	--	--	--	--	--	--	--	220	1100
	1	1 x 4	0.33	0.43	--	--	--	--	--	--	--	170	870
	1	1-1/2 x 1-1/2	0.49	--	--	--	--	--	--	--	--	110	580
	1-1/4	1-1/2 x 1-1/2	0.26	0.34	--	--	--	--	--	--	--	140	870
	1-1/2*	1-1/2 x 1-1/2	0.17	0.22	0.34	--	--	--	--	--	--	260	1300
	2	2 x 2	0.08	0.10	0.16	0.24	0.32	0.47	--	--	--	340	1700
46	1	1 x 4	0.48	--	--	--	--	--	--	--	--	140	720
	1-1/4	1-1/2 x 1-1/2	0.37	0.49	--	--	--	--	--	--	--	120	720
48	1	3/4 x 4	0.48	--	--	--	--	--	--	--	--	170	800
	1-1/2*	1-1/2 x 1-1/2	0.28	0.37	--	--	--	--	--	--	--	200	1000
	2	2 x 2	0.14	0.18	0.28	0.42	--	--	--	--	--	260	1300
54	1-1/2*	1-1/2 x 1-1/2	0.42	--	--	--	--	--	--	--	--	150	790
	2	2 x 2	0.21	0.27	0.42	--	--	--	--	--	--	200	1030
60	2	2 x 2	0.37	0.47	--	--	--	--	--	--	--	160	830

\*Also represents load data for Micro-Mesh 1-1/2" deep x 3/4" square top mesh grating (4' x 12') panel.

**NOTES:**

1. All gratings were tested in accordance with the ANSI Standard: FRP Composites Grating Manual for Pultruded and Molded Grating and Stair Treads.
2. Maximum Recommended Load represents a 5:1 factor of safety on Ultimate Capacity.
3. For covered grating use a multiplier of 0.5. This is limited to gratings of 1" - 2" depths. It is not recommended covering 3/4" or 1/2" gratings.
4. Max recommended and ultimate loads do not change as a result of adding a 1/8" deep covered plate.
5. Gratings in this table are not rated for motorized vehicle traffic. For these applications, please select appropriate High Load Capacity grating.

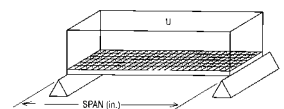

# Load Tables - Fibergrate® Molded Gratings

MOLDED GRATING CONCENTRATED POINT LOAD TABLES - DEFLECTION IN INCHES									
CLEAR SPAN (in)	STYLE		LOAD (lb)						
	DEPTH (in)	MESH (in x in)	50	100	200	300	500	1000	2000
18	5/8	1 x 4	0.08	0.16	0.32	0.48	--	--	--
	1	1 x 4	<.01	0.01	0.02	0.03	0.06	0.11	0.22
	1	1-1/2 x 1-1/2	<.01	0.01	0.03	0.04	0.07	0.14	0.27
	1	2 x 2	0.04	0.08	0.16	0.24	0.40	--	--
	1-1/2*	1-1/2 x 1-1/2	<.01	<.01	0.01	0.02	0.03	0.06	0.13
	2	2 x 2	<.01	<.01	0.01	0.02	0.03	0.05	0.1
24	5/8	1 x 4	0.19	0.38	--	--	--	--	--
	1	1 x 4	0.01	0.02	0.05	0.07	0.12	0.24	0.49
	1	1-1/2 x 1-1/2	0.01	0.03	0.05	0.08	0.13	0.26	--
	1	2 x 2	0.1	0.19	0.38	--	--	--	--
	1-1/4	1-1/2 x 1-1/2	<.01	0.01	0.03	0.04	0.07	--	--
	1-1/2*	1-1/2 x 1-1/2	<.01	0.01	0.02	0.03	0.06	0.12	0.23
30	2	2 x 2	<.01	<.01	0.01	0.02	0.04	0.07	0.14
	5/8	1 x 4	0.37	--	--	--	--	--	--
	1	1 x 4	0.02	0.05	0.09	0.14	0.23	0.45	--
	1	1-1/2 x 1-1/2	0.03	0.05	0.1	0.15	0.26	--	--
	1	2 x 2	0.19	0.37	--	--	--	--	--
	1-1/4	1-1/2 x 1-1/2	0.01	0.03	0.05	0.08	0.13	--	--
36	1-1/2*	1-1/2 x 1-1/2	0.01	0.02	0.04	0.06	0.1	0.2	--
	2	2 x 2	<.01	0.01	0.02	0.03	0.06	0.12	0.23
	1	1 x 4	0.04	0.07	0.14	0.21	0.35	--	--
	1	1-1/2 x 1-1/2	0.03	0.07	0.14	0.2	0.34	--	--
	1	2 x 2	0.32	--	--	--	--	--	--
	1-1/4	1-1/2 x 1-1/2	0.02	0.03	0.07	0.10	0.16	--	--
42	1-1/2*	1-1/2 x 1-1/2	0.02	0.03	0.06	0.09	0.15	0.3	--
	2	2 x 2	<.01	0.01	0.03	0.04	0.07	0.15	0.29
	1	1 x 4	0.05	0.11	0.21	0.32	--	--	--
	1	1-1/2 x 1-1/2	0.06	0.12	0.23	0.35	--	--	--
	1-1/4	1-1/2 x 1-1/2	0.03	0.06	0.11	0.17	0.28	--	--
46	1-1/2*	1-1/2 x 1-1/2	0.02	0.04	0.09	0.13	0.22	0.44	--
	2	2 x 2	0.01	0.02	0.05	0.08	0.12	0.25	0.5
	1	1 x 4	0.07	0.13	0.26	0.39	--	--	--
48	1	1-1/2 x 1-1/2	0.07	0.14	0.28	0.42	--	--	--
	1-1/4	1-1/2 x 1-1/2	0.04	0.07	0.15	0.22	0.37	--	--
54	1-1/2*	1-1/2 x 1-1/2	0.03	0.06	0.12	0.18	0.29	--	--
	2	2 x 2	0.01	0.03	0.06	0.09	0.15	0.3	--
58	1-1/2*	1-1/2 x 1-1/2	0.04	0.07	0.15	0.22	0.37	--	--
	1-1/2*	1-1/2 x 1-1/2	0.04	0.08	0.17	0.25	0.42	--	--

\* Also represents load data for Micro-Mesh 1-1/2" deep x 3/4" square top mesh grating (4' x 12') panel.

**NOTES:**

1. All gratings were tested in accordance with the ANSI Standard: FRP Composites Grating Manual for Pultruded and Molded Grating and Stair Treads.
2. Maximum Recommended Load represents a 5:1 factor of safety on Ultimate Capacity.
3. For covered grating use a multiplier of 0.5. This is limited to gratings of 1" - 2" depths. It is not recommended covering 3/4" or 1/2" gratings.
4. Max recommended and ultimate loads do not change as a result of adding a 1/8" deep covered plate.
5. Gratings in this table are not rated for motorized vehicle traffic. For these applications, please select appropriate High Load Capacity grating.

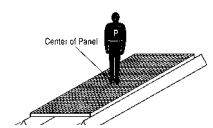

# Load Tables - Fibergate® Molded Gratings

MOLDED GRATING CONCENTRATED LINE LOAD TABLES - DEFLECTION IN INCHES										MAX RECOM. LOAD (lb/ft of width)	ULTIMATE CAPACITY (lb/ft of width)
CLEAR SPAN (in)	STYLE		LOAD (lb/ft of width)								
	DEPTH (in)	MESH (in x in)	50	100	200	300	500	1000	2000		
12	5/8	1 x 4	0.02	0.04	0.09	0.13	--	--	--	770	3860
	3/4	1 x 4	<.01	.01	0.02	0.04	0.06	0.12	--	670	4060
	3/4	1-1/2 x 1-1/2	0.01	0.02	0.04	0.06	0.10	--	--	500	3000
	1	3/4 x 3/4	<.01	<.01	0.02	0.03	0.05	0.1	0.2	880	4440
	1	3/4 x 4	<.01	<.01	0.01	0.02	0.03	0.07	0.13	1400	7020
	1	1 x 4	<.01	0.01	0.02	0.02	0.04	0.08	--	1070	5350
	1	1-1/2 x 1-1/2	<.01	0.01	0.03	0.04	0.06	0.13	--	710	3560
	1	2 x 2	0.02	0.03	0.06	0.09	--	--	--	510	2570
	1-1/4	1-1/2 x 1-1/2	<.01	<.01	0.01	0.02	0.03	0.06	--	110	6660
	1-1/2*	1-1/2 x 1-1/2	<.01	<.01	0.01	0.02	0.03	0.05	0.11	1600	8000
2	2 x 2	<.01	<.01	<.01	0.01	0.02	0.03	0.06	1920	9620	
18	5/8	1 x 4	0.06	0.12	0.23	0.35	--	--	--	510	2560
	3/4	1 x 4	0.02	0.04	0.08	0.12	0.20	--	--	450	2710
	3/4	1-1/2 x 1-1/2	0.03	0.06	0.13	0.19	0.32	--	--	330	2000
	1	3/4 x 3/4	0.01	0.03	0.06	0.09	0.15	0.29	--	590	2960
	1	3/4 x 4	0.01	0.02	0.04	0.06	0.11	0.21	0.43	930	4680
	1	1 x 4	0.01	0.02	0.05	0.07	0.12	0.23	--	710	3560
	1	1-1/2 x 1-1/2	0.02	0.04	0.08	0.12	0.2	0.41	--	470	2370
	1	2 x 2	0.04	0.08	0.16	--	--	--	--	340	1710
	1-1/4	1-1/2 x 1-1/2	0.01	0.02	0.04	0.06	0.10	--	--	540	3240
	1-1/2*	1-1/2 x 1-1/2	0.01	0.02	0.03	0.05	0.08	0.15	0.3	1060	5330
2	2 x 2	<.01	0.01	0.02	0.03	0.05	0.09	0.18	1390	6960	
24	5/8	1 x 4	0.12	0.24	0.48	--	--	--	--	380	1920
	3/4	1 x 4	0.05	0.09	0.19	0.28	0.47	--	--	330	2030
	3/4	1-1/2 x 1-1/2	0.07	0.15	0.30	0.44	--	--	--	250	1500
	1	3/4 x 3/4	0.03	0.07	0.13	0.2	0.33	--	--	440	2220
	1	3/4 x 4	0.02	0.05	0.10	0.15	0.24	0.48	--	700	3510
	1	1 x 4	0.03	0.06	0.12	0.18	0.3	--	--	530	2670
	1	1-1/2 x 1-1/2	0.05	0.1	0.2	0.3	0.49	--	--	350	1780
	1	2 x 2	0.09	0.17	--	--	--	--	--	250	1280
	1-1/4	1-1/2 x 1-1/2	0.02	0.05	0.09	0.14	0.23	--	--	460	2760
	1-1/2*	1-1/2 x 1-1/2	0.02	0.03	0.07	0.1	0.17	0.33	--	800	4000
2	2 x 2	0.01	0.02	0.03	0.05	0.08	0.16	--	1040	5220	
30	5/8	1 x 4	0.2	0.41	--	--	--	--	--	300	1530
	3/4	1 x 4	0.08	0.17	0.34	--	--	--	--	270	1620
	3/4	1-1/2 x 1-1/2	0.11	0.22	0.45	--	--	--	--	200	1200
	1	3/4 x 3/4	0.06	0.13	0.25	0.38	--	--	--	350	1770
	1	3/4 x 4	0.05	0.09	0.19	0.28	0.47	--	--	560	2800
	1	1 x 4	0.05	0.11	0.22	0.32	--	--	--	420	2140
	1	1-1/2 x 1-1/2	0.09	0.18	0.35	--	--	--	--	280	1420
	1	2 x 2	0.15	0.31	--	--	--	--	--	200	1020
	1-1/4	1-1/2 x 1-1/2	0.05	0.10	0.19	0.29	0.49	--	--	350	2130
	1-1/2*	1-1/2 x 1-1/2	0.03	0.06	0.12	0.18	0.29	--	--	640	3200
2	2 x 2	0.01	0.03	0.06	0.09	0.14	0.29	--	830	4180	
36	5/8	1 x 4	0.32	--	--	--	--	--	--	250	1270
	3/4	1 x 4	0.13	0.27	--	--	--	--	--	220	1350
	3/4	1-1/2 x 1-1/2	0.21	0.42	--	--	--	--	--	160	1000
	1	3/4 x 3/4	0.11	0.21	0.42	--	--	--	--	290	1480
	1	3/4 x 4	0.08	0.16	0.33	0.49	--	--	--	460	2340
	1	1 x 4	0.09	0.17	0.34	--	--	--	--	350	1780
	1	1-1/2 x 1-1/2	0.16	0.33	--	--	--	--	--	230	1180
	1	2 x 2	0.25	0.49	--	--	--	--	--	170	850
	1-1/4	1-1/2 x 1-1/2	0.07	0.15	0.30	0.45	--	--	--	290	1770
	1-1/2*	1-1/2 x 1-1/2	0.05	0.11	0.21	0.32	--	--	--	530	2660
2	2 x 2	0.02	0.05	0.09	0.14	0.23	0.47	--	690	3480	
42	1	3/4 x 3/4	0.17	0.34	--	--	--	--	--	250	1260
	1	3/4 x 4	0.13	0.26	--	--	--	--	--	400	2000
	1	1 x 4	0.15	0.3	--	--	--	--	--	300	1520
	1	1-1/2 x 1-1/2	0.26	0.45	--	--	--	--	--	200	1010
	1	2 x 2	0.38	--	--	--	--	--	--	140	730
	1-1/4	1-1/2 x 1-1/2	0.12	0.24	0.48	--	--	--	--	250	1520
	1-1/2*	1-1/2 x 1-1/2	0.08	0.16	0.32	0.47	--	--	--	450	2280
2	2 x 2	0.04	0.07	0.14	0.22	0.36	--	--	590	2980	
46	1	1 x 4	0.20	0.40	--	--	--	--	--	270	1390
	1	1-1/2 x 1-1/2	0.32	--	--	--	--	--	--	180	900
	1-1/4	1-1/2 x 1-1/2	0.16	0.31	--	--	--	--	--	230	1390
48	1	3/4 x 3/4	0.25	--	--	--	--	--	--	220	1110
	1	3/4 x 4	0.19	0.39	--	--	--	--	--	350	1750
	1-1/2*	1-1/2 x 1-1/2	0.11	0.23	0.45	--	--	--	--	400	2000
2	2 x 2	0.06	0.11	0.22	0.33	--	--	--	520	2610	
54	1-1/2*	1-1/2 x 1-1/2	0.15	0.3	--	--	--	--	--	350	1770
	2	2 x 2	0.07	0.15	0.3	0.45	--	--	--	460	2320
60	2	2 x 2	0.12	0.23	0.47	--	--	--	410	2090	

\* Also represents load data for Micro-Mesh 1-1/2" deep x 3/4" square top mesh grating (4' x 12') panel.

**NOTES:**

- All gratings were tested in accordance with the ANSI Standard: FRP Composites Grating Manual for Pultruded and Molded Grating and Stair Treads.
- Maximum Recommended Load represents a 5:1 factor of safety on Ultimate Capacity.
- For covered grating use a multiplier of 0.5. This is limited to gratings of 1" - 2" depths. It is not recommended covering 3/4" or 1/2" gratings.
- Max recommended and ultimate loads do not change as a result of adding a 1/8" deep covered plate.
- Gratings in this table are not rated for motorized vehicle traffic. For these applications, please select appropriate High Load Capacity grating.

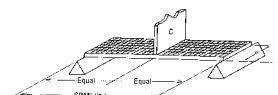

# High Load Capacity Grating Details

Molded High Load Capacity (HLC) grating is yet another product in the arsenal of engineered fiberglass reinforced plastic (FRP) solutions by Fibergate. While capitalizing on most of the traditional benefits of molded grating products — high strength, corrosion resistance, fire retardancy, non conductivity and low maintenance — this specially manufactured molded FRP product has been engineered to carry forklift loads that traditional molded FRP grating products are unable to support.

With a 48% open surface area, Fibergate molded HLC grating is available in a 6' x 4' or 4' x 8' panel size with depths of 1-1/2" and 2". High load capacity molded grating is now available in Fibergate's Vi-Corr®, Corvex® and FGI-AM® resin systems (see resin details for color options). Surface options include either a smooth surface or an Aluminum Oxide (A/O) grit surface. Fibergate molded HLC grating merits an ASTM E-84 flame spread rating of 25 or less and a Class 1 Fire Rating.

6' x 4' Finished Panel Size

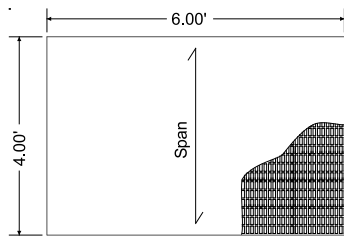

**Note:** Load carrying bars are oriented across the narrow (4') dimension of the panel. Panels furnished with closed bars all sides.

4' x 8' Finished Panel Size

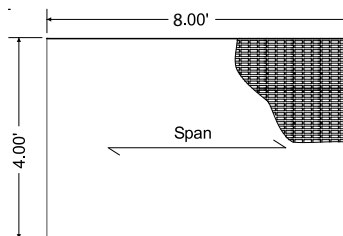

**Note:** Load carrying bars are oriented across the long (8') dimension of the panel. Panels furnished with closed bars all sides.

## HLC 1-1/2" Deep x 1" x 2" Rectangular Mesh

# of Bars/ Ft of Width	Load Bar Width	Open Area	Load Bar Centers	Approximate Weight
12	0.43"	48%	1"	6.2 psf

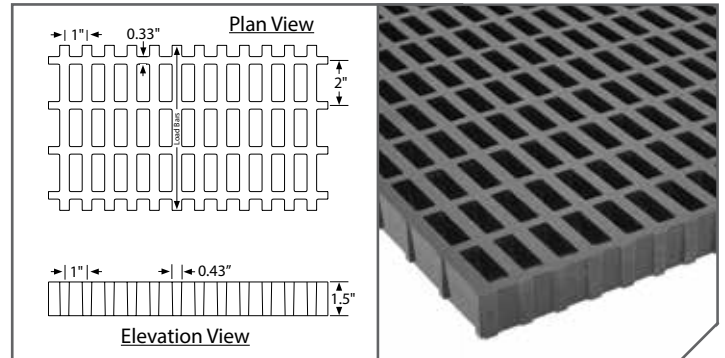

Section Properties per Ft of Width:  $A = 7.45 \text{ IN}^2$   $I = 1.39 \text{ IN}^4$   $S = 1.80 \text{ IN}^3$

## HLC 2" Deep x 1" x 2" Rectangular Mesh

# of Bars/ Ft of Width	Load Bar Width	Open Area	Load Bar Centers	Approximate Weight
12	0.48"	48%	1"	8.4 psf

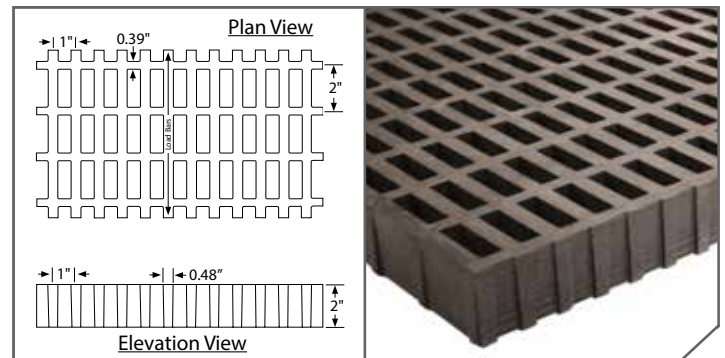

Section Properties per Ft of Width:  $A = 10.26 \text{ IN}^2$   $I = 3.4 \text{ IN}^4$   $S = 3.27 \text{ IN}^3$

## Allowable Spans for Vehicular Loads

	Wheel Load (lb) - 1/2 Axle Load +30% Impact	Load Distribution		Allowable Span <sup>2,3</sup>	
		Parallel To Axle <sup>1</sup>	Perpendicular To Axle	1-1/2" Deep HLC Molded Grating	2" Deep HLC Molded Grating
AASHTO Standard Truck <sup>4</sup> / 32,000 lb Axle Load Dual Wheels (*formerly AASHTO H-20)	20,800	20" + 4"	8"	1' - 2"	1' - 5"
Automobile Traffic / 5,000 lb Vehicle 1,500 lb Load / 55% Drive Axle Load	2,200	8" + 4"	8"	2' - 2"	2' - 8"
5 ton Capacity Forklift / 14,400 lb Vehicle 24,400 lb Total Load / 85% Drive Axle Load	13,480	11" + 4"	11"	1' - 1"	1' - 5"
3 Ton Capacity Forklift / 9,800 lb Vehicle 15,800 lb Total Load / 85% Drive Axle Load	8,730	7" + 4"	7"	1' - 0"	1' - 4"
1 Ton Capacity Forklift / 4,200 lb Vehicle 6,200 lb Total Load / 85% Drive Axle Load	3,425	4" + 4"	4"	1' - 7"	2' - 1"

**Notes:**

- Load is carried by the grating load bars immediate under wheel + four additional load bars adjacent to wheel.
- Allowable Span is based on a 0.25" maximum deflection and a Factor of Safety of 2.5. Other criteria may be required by certain construction codes. Check code requirements to determine design criteria.
- ALLOWABLE SPAN IS STRONGLY DEPENDENT ON WHEEL WIDTH AND VEHICLE WEIGHT/LOAD CAPACITY.** If your application varies from the values given on this table, contact Fibergate Engineering for application assistance.
- Load based on the AASHTO Standard Truck Load as defined in AASHTO LRFD Bridge Design Specifications, 2nd Ed. This does not imply that the allowable span meets the deflection requirements of this specification.

# HLC Grating Load Charts

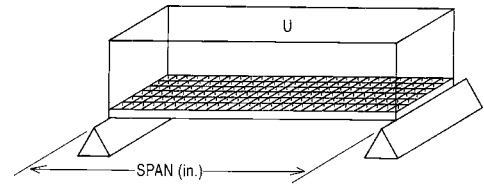

**Uniform Load Table - Deflection in Inches**

Span (in)	Style		UNIFORM LOAD (psf)										MAXIMUM RECOMMENDED LOAD (psf)	ULTIMATE CAPACITY (psf)	
	Depth (in)	Mesh (in)	100	200	300	400	500	600	700	800	900	1000			
12	1-1/2	1 x 2	<0.01	<0.01	<0.01	<0.01	<0.01	<0.01	<0.01	<0.01	<0.01	<0.01	<0.01	28000	70000
	2	1 x 2	<0.01	<0.01	<0.01	<0.01	<0.01	<0.01	<0.01	<0.01	<0.01	<0.01	<0.01	31200	78000
18	1-1/2	1 x 2	<0.01	<0.01	0.01	0.01	0.02	0.02	0.02	0.03	0.03	0.03	0.03	12400	31000
	2	1 x 2	<0.01	<0.01	0.01	0.01	0.01	0.01	0.01	0.02	0.02	0.02	0.02	14500	36200
24	1-1/2	1 x 2	0.01	0.02	0.03	0.04	0.05	0.06	0.08	0.09	0.10	0.11	0.11	6800	17000
	2	1 x 2	0.01	0.01	0.02	0.02	0.03	0.04	0.04	0.05	0.05	0.06	0.06	9000	22500
30	1-1/2	1 x 2	0.03	0.05	0.08	0.11	0.13	0.16	0.18	0.21	0.24	0.26	0.26	4300	10700
	2	1 x 2	0.01	0.03	0.04	0.06	0.07	0.09	0.10	0.11	0.13	0.14	0.14	5800	14500
36	1-1/2	1 x 2	0.05	0.10	0.16	0.21	0.26	0.31	0.37	0.42	0.47	--	--	3000	7500
	2	1 x 2	0.03	0.06	0.09	0.12	0.15	0.18	0.21	0.24	0.27	0.30	0.30	4000	10000
42	1-1/2	1 x 2	0.10	0.19	0.29	0.39	0.48	--	--	--	--	--	--	2200	5500
	2	1 x 2	0.06	0.11	0.17	0.22	0.28	0.33	0.39	0.44	0.50	--	--	2900	7200

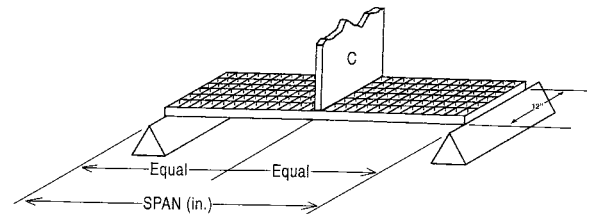

**Concentrated Line Load Table - Deflection in Inches**

Span (in)	Style		Concentrated Line LOAD (lb/ft of width)										MAXIMUM RECOMMENDED LOAD (lb/ft)	ULTIMATE CAPACITY (lb/ft)	
	Depth (in)	Mesh (in)	100	200	300	500	1000	2000	3000	4000	5000	6000			
12	1-1/2	1 x 2	<0.01	<0.01	<0.01	<0.01	0.01	0.03	0.04	0.06	0.07	0.08	0.08	14000	35000
	2	1 x 2	<0.01	<0.01	<0.01	<0.01	0.01	0.02	0.02	0.03	0.04	0.05	0.05	15600	39000
18	1-1/2	1 x 2	<0.01	<0.01	0.01	0.02	0.04	0.07	0.11	0.15	0.18	0.22	0.22	9300	23200
	2	1 x 2	<0.01	<0.01	0.01	0.01	0.02	0.04	0.06	0.08	0.11	0.13	0.13	10800	27000
24	1-1/2	1 x 2	<0.01	0.02	0.03	0.04	0.09	0.17	0.26	0.34	0.43	--	--	6800	17000
	2	1 x 2	<0.01	0.01	0.01	0.02	0.05	0.09	0.14	0.19	0.24	0.28	0.28	9000	22500
30	1-1/2	1 x 2	0.02	0.03	0.05	0.08	0.17	0.34	--	--	--	--	--	5400	13500
	2	1 x 2	0.01	0.02	0.03	0.05	0.09	0.18	0.28	0.37	0.46	--	--	7200	18000
36	1-1/2	1 x 2	0.03	0.06	0.08	0.14	0.28	--	--	--	--	--	--	4500	11200
	2	1 x 2	0.02	0.03	0.05	0.08	0.16	0.32	0.48	--	--	--	--	6000	15000
42	1-1/2	1 x 2	0.04	0.09	0.13	0.22	0.44	--	--	--	--	--	--	3800	9500
	2	1 x 2	0.03	0.05	0.08	0.13	0.25	0.50	--	--	--	--	--	5100	12700

**NOTES:**

1. ULTIMATE CAPACITY represents a complete and total failure of the grating. Values are provided to illustrate the reserve strength of the grating at a given span and are NOT to be used for design. Functionality of grating is limited to MAX RECOMMENDED LOAD.
2. The allowable loads in this table are for STATIC LOAD CONDITIONS at ambient temperatures only. Allowable loads for impact conditions should be a maximum of ONE-HALF the values shown. Long term loads will result in added deflection due to creep in the material and will also require higher safety factors to ensure acceptable performance. For applications at elevated temperatures, consult factory. The designer is further referenced to ASCE Structural Plastics Design Manual.
3. Fibergate recommends a maximum deflection of 0.25" for this product under normal loading conditions. The use of L/500 may be required by certain construction codes. Check code requirements to determine design criteria.
4. All gratings were tested in accordance with the ANSI Standard: FRP Composites Grating Manual for Pultruded and Molded Grating and Stair Treads.

# Stair Solutions

## Stair Treads



Fibergate provides several slip and corrosion resistant products for your stairway safety needs. Our complete stair solution line includes panels in a one-piece molded configuration for new or replacement steps; covered stair treads to replace deteriorating concrete steps; or stair tread covers designed to add

slip and corrosion resistance to existing metal, concrete or wood steps. Stair treads are available in a one-piece molded configuration engineered to exceed OSHA and other model building code standards for safety, strength, durability and corrosion resistance.

## Fibertred® Panels

Fibertred stair treads are available in the same high performance resin formulations as Fibergate grating. Unique cutting channels spaced at 6" intervals provide efficient utilization when custom fitting treads into stairways. These channels also ensure that all standard stair tread widths are terminated with closed ends. Up to five 24" wide stair treads can be cut from each side of a single panel. A 1-1/2" wide gritted strip is molded in on both sides of the panel for superior slip resistance.

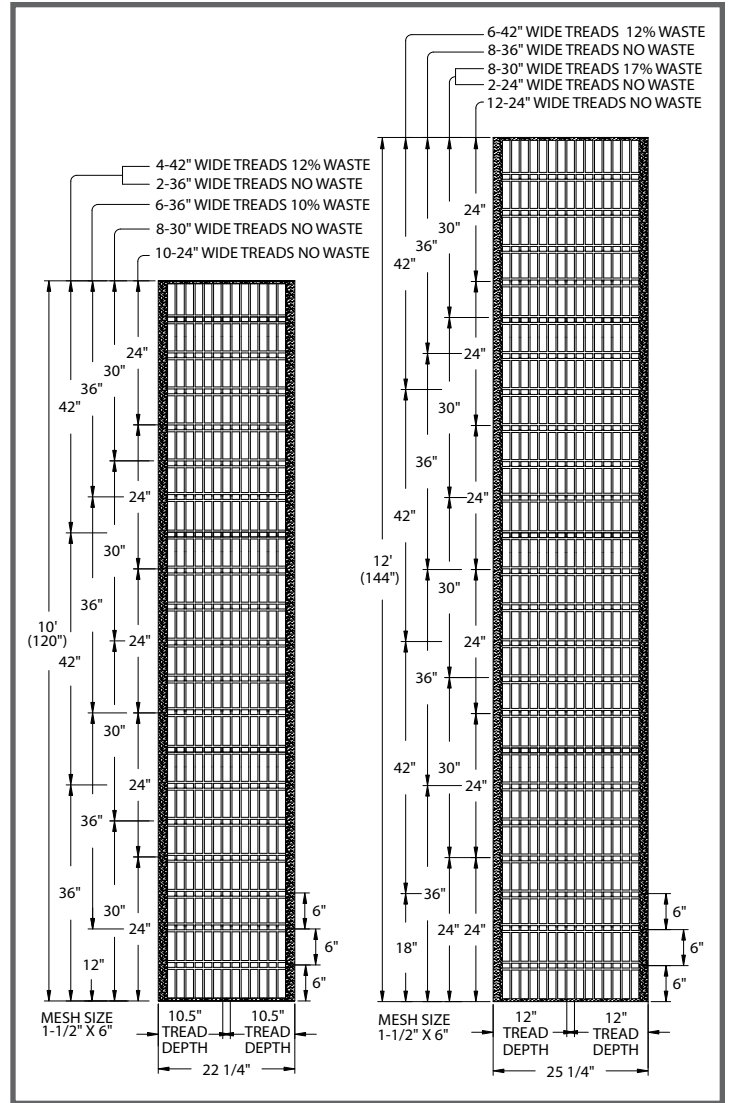

## Fibertred® Load Table

Load (lb)	Span (in)	18	24	30	36	42	48
	Span/150	0.12	0.16	0.20	0.24	0.28	0.32
250		0.03	0.05	0.09	0.16	0.25	0.41
500		0.06	0.10	0.19	0.32	0.50	--

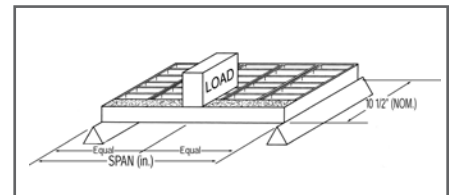

### NOTES:

1. It is suggested that stair tread deflections be limited to Span/150. Deflections based on this ratio are at the top of the table.
2. Deflections in the body of the table are for concentrated loads of both 250 and 500 lb. A concentrated load is applied at the center line of the tread, over a width of 4" and a depth of 6", starting at the nosing edge to simulate the landing of a foot.
3. Stair treads with square mesh or for longer spans are available by custom order. Please contact Fibergate for more information.

# Stair Solutions

## Stair Tread Covers

Fiberplate® stair tread covers are a convenient way to provide solid slip resistant footing for existing stairs. Stair tread covers may be installed over wood, concrete or metal steps. Standard color is dark gray with a highly visible safety yellow nosing and light gray for architectural applications.

An integral aluminum oxide grit-top surface provides secure footing for maximum safety and a highly durable tread. Reinforced with a woven glass mat for durability and impact resistance, these tread covers come in 8", 9", 10", 11" and 12" depths. The standard thickness is 1/8", with 1/4" thick covers available for heavy duty applications. Standard 12' panels are easily cut to size during installation, or are available precut to custom lengths. Also available in a phosphorescent glow in the dark coating for the nosing area.

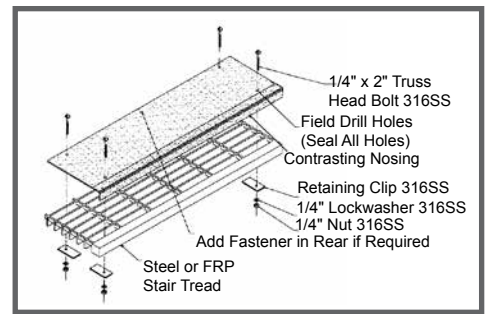
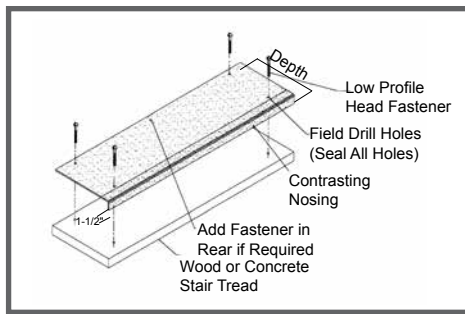
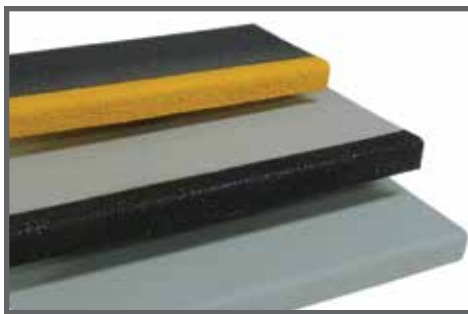

## Covered Stair Treads / Load Table

Designed as an alternative to high-maintenance concrete or slippery metal steps, covered stair treads are designed for commercial and architectural applications where aesthetics and low maintenance are important considerations. Covered stair treads are available in Corvex® resin and have an integral grit top which comes in two textures — coarse and fine which is suitable even for barefoot traffic. They can withstand many corrosive environments including salt, continuous moisture and constant cleaning. The tread is 80 percent lighter than that of a precast concrete step. Simple wood working tools with abrasive blades make for easy fabrication and installation.



Installed with standard WLP clip assembly

Tread Type (Depth x Width)	Load (lb)	Span (in) L/D=150	30	36	42	48	54	60
			0.2	0.24	0.28	0.32	0.36	0.4
1-5/8" x 10-5/8"	250		0.08	0.15	0.23	0.35	--	--
	500		0.17	0.29	0.47	--	--	--
1-5/8" x 12-1/4"	250		0.07	0.11	0.18	0.27	0.37	--
	500		0.13	0.23	0.36	--	--	--
2-1/8" x 10-1/4"	250		0.04	0.06	0.09	0.14	0.20	0.27
	500		0.07	0.13	0.19	0.28	0.39	--
2-1/8" x 12-1/4"	250		0.03	0.05	0.08	0.12	0.17	0.23
	500		0.05	0.10	0.17	0.24	0.33	0.46

## Optional Hidden Hold Down System

Contact your local Fibergrate sales person for more information. Visit [fibergrate.com](http://fibergrate.com) or call us at (800) 527-4043.



# Floor Plate



Fiberplate® is manufactured by building up multiple layers of fiberglass reinforcement and specially-formulated resins. The result of this process is a solid composite panel offering both bidirectional strength and corrosion resistance.

This specially designed product is nonporous, is easily cleaned by a high pressure washer and can withstand cleaning solutions. Available in all molded grating resin systems (see page 7). Standard panel sizes are 3' x 10', 4' x 8', 4' x 12' and 5' x 10'. (Custom sizes also available.)

## Fiberplate® Load and Deflection Data

\*Important: 1/8" Plate designed for use as covering only; not recommended for load bearing service.

Depth (in)	Span (in)	Concentrated Load-Full Panel							Uniform Load-Full Panel						Concentrated Load Required to Produce Deflection Equal to 1% of Span (lb)	
		Maximum Load		Load (lb)					Maximum Load		Load (psf)					
		Norm <sup>1</sup>	Firm <sup>2</sup>	100	250	500	750	1000	Norm <sup>1</sup>	Firm <sup>2</sup>	25	50	75	100		150
1/4	12	229	135	.047	.104	.199	.294	.392	336	205	.010	.014	.022	.029	.043	300 lb
	18	196	117	.079	.181	.351	--	--	99	54	.056	.085	.115	.145	.204	256 lb
	24	181	116	.102	.268	--	--	--	28	15	.177	.327	.476	--	--	223 lb
	36	84	55	.350	--	--	--	--	--	--	--	--	--	--	103 lb	
3/8	12	515	325	.018	.045	.093	.140	.190	480	300	<.01	--	.016	.020	.030	667 lb
	18	455	288	.028	.077	.158	.239	.320	146	91	.026	.050	.075	.099	.148	584 lb
	24	259	149	.100	.195	.355	--	--	64	40	.075	.150	.225	.300	.449	308 lb
	36	154	98	.178	.467	--	--	--	28	17	.258	--	--	--	--	192 lb
1/2	12	960	600	<.01	.025	.048	.075	.100	654	410	<.01	--	.012	.016	.022	1250 lb
	18	853	543	.011	.011	.038	.081	.125	169	26	.125	.041	.057	.074	.106	1184 lb
	24	508	313	.043	.098	.1490	.282	.374	118	72	.051	.089	.127	.165	.241	631 lb
	36	260	157	.127	.283	--	--	--	49	30	.153	.297	.441	--	--	318 lb
3/4	12	3965	2469	.003	.007	.013	.019	.024	1944	1215	.0012	.0025	.0037	.0049	.0074	4750 lb
	18	1798	1123	.009	.024	.043	.063	.079	576	360	.002	.011	.018	.025	.039	2140 lb
	24	1412	882	.019	.042	.075	.106	.133	243	152	.031	.054	.075	.093	.131	1700 lb
	36	1108	693	.027	.066	.129	.188	.243	85	53	.078	.134	.187	.231	.321	1440 lb

**Notes:**

- (1) Normal load is the load which will produce a L/D of 125 or .375" Maximum.
- (2) Firm is the load which will produce a L/D of 200 or .25" Maximum.
- (3) Loads for Short Span Normal and Firm have been limited to allow for shearing effects.
- (4) Clear Span is 2" less than width of grating.

**Plate Weight**

1/8" - 1.3 psf, 1/4" - 2.6 psf, 3/8" - 3.9 psf, 1/2" - 5.2 psf, 3/4" - 7.8 psf

### Installation

- Install using ordinary hand tools and masonry blade
- Fastener assembly kits may be ordered directly from Fibergrate
- Space fasteners a minimum of 12"-24" apart
- On concrete, use masonry bit and concrete anchor bolts
- On steel, wood or FRP, drill and bolt with truss head assembly
- It is recommended that all cut edges and holes be sealed

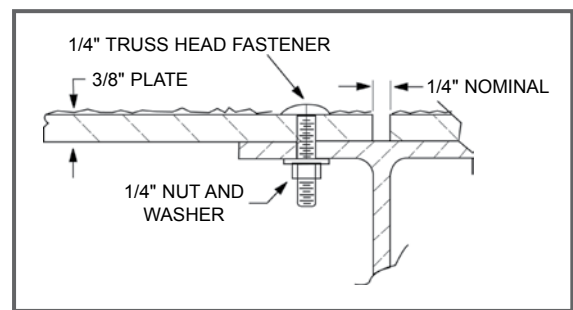



# Accessories & Complementary Products

## Clip Assemblies For Molded Products

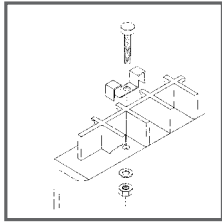

**TYPE M HOLD DOWN CLIPS:** Secure panels to a support in the same manner as Type J Clips, but designed to use two adjacent grating bars for a more secure fit. Similar in design to metal grating saddle clips.

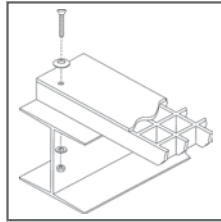

**TYPE WLP STRUCTURAL CLIPS:** Secure covered grating or plate to a structure. (Also available in 304 SS)

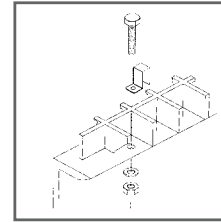

**TYPE J HOLD DOWN CLIPS:** Secure grating panels to support frames.

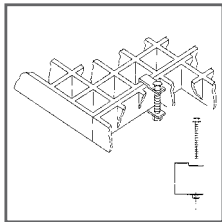

**TYPE F END PANEL CLIPS:** Provide a simplified method for joining factory edges of adjacent abutting panels.

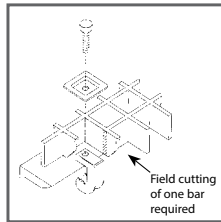

**TYPE G HOLD DOWN CLIPS:** Attach grating to any structural member flange, 3/4" or smaller in thickness, with no drilling required.

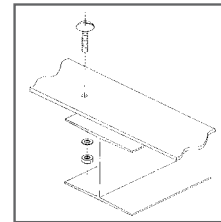

**TYPE H (TRUSS HEAD) STRUCTURAL CLIPS:** Secure plate to a structure.

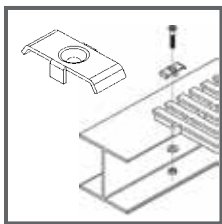

**TYPE EI HOLD DOWN CLIP:** Secure panels to a support.

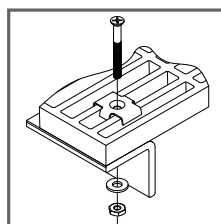

**TYPE E-1 HOLD DOWN CLIP:** Secure panels to a support.

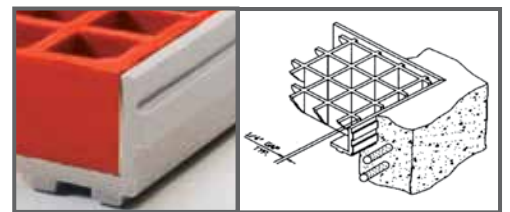

**EZ ANGLE® EMBEDMENT ANGLE:**

Is precision-designed for solid seating of 1", 1-1/2", 2", and 3" deep gratings. EZ Angle embedment angle is stocked in 20' lengths for immediate shipment. For animated installation instructions, visit our resource center at [fibergrate.com](http://fibergrate.com).

## Fibergrate® Pedestals



Made with the same adherence to quality as all Fibergrate products, specially designed pedestals for square mesh molded grating are manufactured to provide safe support for elevated flooring. Pedestal supported floors are versatile; they can be modified or moved from place to place as necessary and pedestals are generally much less expensive than beam support systems. Adjustable pedestals are available in heights from 3-1/4" to 72" (with additional bracing). Pedestals are available with 1-1/2" or 2" single heads or quad heads to fit Fibergrate grating.

## Grating Edge Ramps

Fibergrate's new standard grating edge ramps can be used with 1", 1-1/2", and 2" deep Fibergrate® molded grating. These grating edge ramps are offered in dark gray or yellow and have a quartz grit top surface. Grating edge ramps are stocked in 12' lengths; however, they can be easily fabricated to meet any length requirements.

For additional details, please visit our website at:

<http://fibergrate.com/products/accessories-complementary-products/grating-edge-ramps/>



Fibergrate® molded grating with edge ramp

## Sealing and Bonding Kits

To maintain corrosion resistance and structural integrity, Fibergrate offers epoxy clear coating in a spray can\* for protecting the exposed ends of cut panels and other components. One spray can coats approximately 100 linear feet of cut grating. Bonding kits come in a natural, unpigmented color.

\*1/2 pint sealing kits are still available with minimum order requirements (each 1/2 pint covers 20-40 linear feet).

# Other Molded Products

## Covered Grating

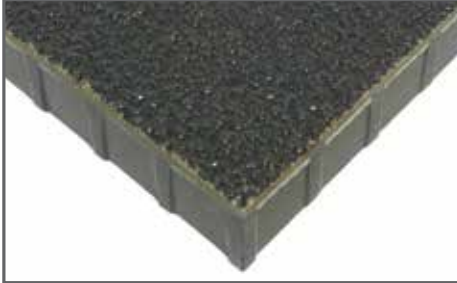

Covered grating is often used in loading and storage areas. Other applications include food processing facilities where covered grating walkways prohibit contamination to conveyor or work surfaces below; facilities where covered grating provides a walking surface and controls subsurface odors; walkways over tank tops and vats; and solid flooring where narrow heels might present a tripping hazard with open mesh grating. Fibergrate® covered grating includes a fiberglass gritted plate cover secondarily affixed to a molded grating panel. Covered grating offers a strong, level surface for foot or cart traffic and provides approximately 50% higher stiffness values than that of open mesh grating. Its standard grit top cover assures secure footing.

Fibergrate covered grating consists of a 1/8" or 1/4" deep plate applied to standard Fibergrate grating depths. Fibergrate covered grating is available in Corvex®, Vi-Corr®, FGI-AM®, ELS and XFR resin systems.

### Notes:

1. Type WLP Hold Down Clips are recommended to secure Fibergrate covered grating panels to structural supports in order to eliminate potential damage to the covered grating. Fibergrate provides 8 WLP Hold Down clips per panel.
2. For load data see pages 9-11 and use a multiplier of 0.5. This is limited to gratings of 1" - 2" depths. It is not recommended covering 3/4" or 1/2" gratings.

## Work Platform Solutions



Work station platforms from Fibergrate are available in a variety of styles, heights and sizes to provide a safe, slip resistant, corrosion resistant and ergonomic solution for your facility. From portable one-piece workstands to fixed large-scale access platforms, Fibergrate will help you find the perfect fit for your working environment.

**Safe-T-Stand®:** Safe-T-Stand platforms have a grit top which provides a safe, slip resistant surface, while their resilient design eases the strain on feet, legs and back muscles. Stands are available in 2", 4", 6", 8" and 10" heights and have skid resistant rubber feet for added safety. The proven strength, impact resistance and overall durability of FRP construction make Safe-T-Stand platforms equally usable in any process industry or manufacturing environment. Standard Safe-T-Stand platforms are manufactured using a specially designed, USDA-approvable, food-grade resin for food and beverage processing plants. The full line of Fibergrate resin systems is available for non-food applications.

**Rubber Feet for Molded Grating:** Specially designed rubber feet are an economical way to create a raised, ergonomic grating workmat for use around machines, lathes and in wet areas. With the rubber feet, facilities have a cost-effective solution to elevate grating needed for drainage or waterflow and safe, ergonomic platforms. The feet raise the grating 1/2" above the ground, and along with the open mesh, protect workers by allowing chips and fluids to fall below the standing surface eliminating slip and fall hazards.

**Fibergrate® Custom Platform Solutions:** Fibergrate's turnkey approach to providing custom platform solutions include design, fabrication and installation services. From simple portable workstations to complex multifaceted platforms, the experienced personnel at Fibergrate can provide your facility with the perfect custom platform solution.

# Chemical Resistance Guide

Chemical Environment	% Concentration	Temp F	Fibergate® Molded				Safe-T-Span® Pultruded	
			Vi-Corr®	Corvex®	FGI-AM®	XFR	VEFR	ISOFR
Acetic Acid	50	MAX	C	C	C	I	C	C
Acetone	100	75	S	I	I	I	I	N
Alcohols	100	120	C	I	I	S	I	I
Alum	ALL	MAX	C	C	C	C	C	C
Aluminum Chloride	ALL	MAX	C	C	C	C	C	C
Aluminum Fluoride	20	75	C	I	I	I	I	I
Ammonium Hydroxide	30	75	C	N	N	N	I	N
Ammonium Salts-Neutral	ALL	120	C	C	C	S	C	S
Ammonium Salts-Aggressive	ALL	75	S	I	I	I	T	N
Aromatic Solvents	ALL	75	T	N	N	N	N	N
Barium Salts	ALL	MAX	C	C	C	C	C	C
Benzene	100	140	I	I	I	I	I	N
Black Liquor (Pulp Mill)	ALL	MAX	C	I	I	I	I	N
Bleach Liquor (Pulp Mill)	ALL	MAX	C	I	I	N	I	N
Calcium Hydroxide	25	MAX	C	S	S	I	S	I
Calcium Hypochlorite	ALL	MAX	C	I	I	I	I	N
Calcium Salts	ALL	MAX	C	C	C	C	C	C
Carbon Tetrachloride	100	75	C	I	I	S	S	N
Chlorinated Hydrocarbons	100	75	T	T	T	N	T	T
Chlorine Dioxide	SAT	140	C	N	N	N	S	N
Chlorine Water	SAT	120	C	I	I	I	I	N
Chlorine, Wet	SAT	MAX	C	N	N	N	N	N
Chlorobenzene	100	75	S	N	N	N	N	N
Chlorobenzene	ALL	Up to 100	C	N	N	N	N	N
Chloroform	100	75	N	N	N	N	N	N
Chromic Acid	50	140	S	S	S	N	I	N
Citric Acid	ALL	MAX	C	C	C	C	C	C
Copper Cyanide Plating	ALL	125	C	S	S	N	S	I
Copper Salts	ALL	MAX	C	C	C	C	C	C
Crude Oil (Sweet or Sour)	ALL	MAX	C	C	C	C	C	C
Dichlorobenzene	100	75	T	N	N	N	N	N
Ethers	75	75	T	N	N	N	N	N
Ferric Chloride	100	MAX	C	C	C	C	C	C
Ferric Salts	ALL	MAX	C	C	C	C	C	C
Fluoride Salts+HCl	ALL	75	C	S	S	I	I	N
Fluosilicic Acid	10	75	C	S	S	S	S	I
Formaldehyde	37	150	C	I	I	I	S	I
Formic Acid	25	100	C	S	S	I	S	I
Fuel (Diesel, Jet, Gasoline)	ALL	100	C	C	C	C	C	C
Glycerine	100	MAX	C	C	C	C	C	C
Green Liquor (Pulp Mill)	ALL	MAX	C	N	N	N	I	N
Hydrobromic Acid	48	MAX	S	S	S	I	I	N
Hydrochloric Acid	10	MAX	C	S	S	C	S	S
Hydrochloric Acid	30	MAX	C	S	S	I	I	I
Hydrochloric Acid (concentrated)	ALL	Up to 180	I	N	N	N	N	N
Hydrocyanic Acid	ALL	MAX	C	I	I	I	S	I
Hydrofluoric Acid	20	75	S	N	N	N	N	N
Hydrogen Peroxide	30	75	C	N	N	I	S	N
Lactic Acid	100	MAX	C	C	C	C	C	C
Lime Slurry	SAT	MAX	C	C	C	C	C	C
Lithium Chloride	SAT	MAX	N	N	N	N	N	N
Lithium Salts	ALL	MAX	C	C	C	C	T	T
Magnesium Salts	ALL	MAX	C	C	C	C	C	C
Maleic Acid	100	MAX	C	S	S	C	S	I
Mercury Chloride	100	MAX	C	C	C	C	C	C
Nickel Salts	ALL	MAX	C	C	C	C	C	C
Nitric Acid	20	120	C	S	S	I	I	I
Nitric Acid	35	100	C	N	N	I	I	N
Nitric Acid	40	Ambient	I	N	N	N	N	N
Nitric, Hydrofluoric	20:2	75	I	N	N	N	N	N
Nitrous Acid	10	75	C	C	C	C	C	C
Ozone for Sewage Treatment	100	100	C	C	C	C	C	C
Perchloroethylene	100	75	S	N	N	I	I	N
Phenol	10	75	C	N	N	N	I	N
Phenol	88	Ambient	S	N	N	N	N	N
Phosphoric Acid	85	MAX	C	C	C	C	C	S
Phosphoric Acid, Super	115	MAX	C	I	I	S	S	N
Potassium Hydroxide	10	120	C	I	I	N	S	N
Potassium Salts	ALL	MAX	C	C	C	C	C	C
Silver Nitrate	100	MAX	C	C	C	C	C	C
Sodium Cyanide	ALL	75	C	I	I	I	S	I
Sodium Hydroxide	50	MAX	C	I	I	N	I	N
Sodium Hydroxide	10	MAX	C	N	N	N	N	N
Sodium Hypochlorite (Stable)	10	100	C	S	S	S	S	I
Sodium Salts-Neutral	ALL	MAX	C	C	C	C	C	C
Sodium Salts-Aggressive	ALL	75	S	I	I	I	T	N
Sulfur Dioxide	SAT	MAX	C	S	S	S	S	S
Sulfuric Acid	25	MAX	C	S	S	S	S	I
Sulfuric Acid	50	MAX	C	S	S	S	S	N
Sulfuric Acid	75	100	C	I	I	I	I	N
Toluene	100	120	S	I	I	N	I	N
Trichloroethane 1,1,1	ALL	75	S	I	I	I	I	N
Trisodium Phosphate	50	MAX	C	I	I	I	I	N
Water (Fresh, Salt, Moderate D.I.)	100	MAX	C	C	C	C	C	C
Wet Chlorine/Hydrochloric Acid	10-20	Up to 350	S	N	N	N	N	N
White Liquor (Pulp Mill)	ALL	MAX	C	I	I	I	S	N
Zinc Chloride Plating	ALL	75	C	S	S	S	S	N
Zinc Salts	100	MAX	C	C	C	C	C	C

C - Continuous exposure of the grating to the Chemical Environment listed at the temperature listed.  
 S - Frequent exposure of the grating to splashes and spills from the Chemical Environment listed with that environment at the temperature listed.  
 I - Infrequent exposure of the grating to splashes and spills from the Chemical Environment listed with that environment at the temperature listed and the spill immediately cleaned up or washed from the grating.  
 N - Not recommended for the concentrations and temperatures listed.  
 T - Test

Consult Fibergate for corrosion recommendations at concentrations, temperatures or chemicals not listed in this guide.  
 MAX TEMP is 180°F for ViCorr and Pultruded VEFR; 150° for Corvex, FGI-AM, XFR and Pultruded ISOFR.  
 The information in this Corrosion Guide is correct to the best of Fibergate's knowledge. It is based on extensive experience with fiberglass grating in corrosive applications. Because actual use conditions differ and mixtures of corrosives will occur in service, the end user must test for use under actual conditions. Fibergate's responsibility for claims arising from breach of warranty, negligence, or otherwise is limited to the purchase price of the material sold by Fibergate. Test coupons are available upon specific request.

# Fibergrate Products & Services



## Fibergrate® Molded Grating

Fibergrate® molded gratings are designed to provide the ultimate in reliable performance, even in the most demanding conditions. Fibergrate offers the widest selection in the market with multiple resins and more than twenty grating configurations available in many panel sizes and surfaces.



## Safe-T-Span® Pultruded Industrial & Pedestrian Gratings

Combining corrosion resistance, long-life and low maintenance, Safe-T-Span® provides unidirectional strength for industrial and pedestrian pultruded grating applications.



## Dynaform® Structural Shapes

Fibergrate offers a wide range of standard Dynaform® pultruded structural profiles for industrial and commercial use, including I-beams, wide flange beams, round and square tubes, bars, rods, channels, leg angles and plate.



## Dynarail® & DynaRound™ Guardrail, Handrail & Ladders

Easily assembled from durable components or engineered and prefabricated to your specifications, Dynarail® square tube and DynaRound™ round tube railing systems and Dynarail® safety ladder systems meet or exceed OSHA and strict building code requirements for safety and design.

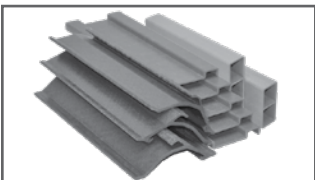

## Custom Composite Solutions

Combining Fibergrate's design, manufacturing and fabrication services allows Fibergrate to offer custom composite solutions to meet our client's specific requirements. Either through unique pultruded profiles or custom open molding, Fibergrate can help bring your vision to reality.



## Design & Fabrication Services

Combining engineering expertise with an understanding of fiberglass applications, Fibergrate provides turnkey design and fabrication of fiberglass structures, including platforms, catwalks, stairways, railings and equipment support structures.



## Worldwide Sales & Distribution Network

Whether a customer requires a platform in a mine in South Africa to grating on an oil rig in the North Sea, or walkways in a Wisconsin cheese plant to railings at a water treatment facility in Brazil; Fibergrate has sales and service locations throughout the world to meet the needs and exceed the expectations of any customer.

Fibergrate Composite Structures Inc. believes the information contained here to be true and accurate. Fibergrate makes no warranty, expressed or implied, based on this literature and assumes no responsibility for the consequential or incidental damages in the use of these products and systems described, including any warranty of merchantability or fitness. Information contained here can be for evaluation only. The marks and trade names appearing herein, whether registered or unregistered, are the property of Fibergrate Composite Structures Inc.

General Disclaimer: Microban® antimicrobial product protection is limited to the product itself and is not designed to protect the users of these products from disease causing microorganisms, food borne illnesses, or as a substitute for normal cleaning and hygiene practices. Microban International, Ltd. makes neither direct nor implied health claims for the products containing Microban® antimicrobial product protection. Data, photomicrographs and information presented are based on standard laboratory tests and are provided for comparative purposes to substantiate antimicrobial activity for non-public health uses.

Trademark Disclaimer: Microban® is a registered trademark of Microban Products Company.

©Fibergrate Inc. 2019 Part No. 885105-11/23-1.5 Printed in the USA

[fibergrate.com](http://fibergrate.com) | (800) 527-4043



Fax: (972) 250-1530 | Email: [info@fibergrate.com](mailto:info@fibergrate.com)